

Data Sheet



Article number: 339703130000

Description: Multibeam 6 Coupling 703.13.0000
St. steel & clamp hubs

Measures

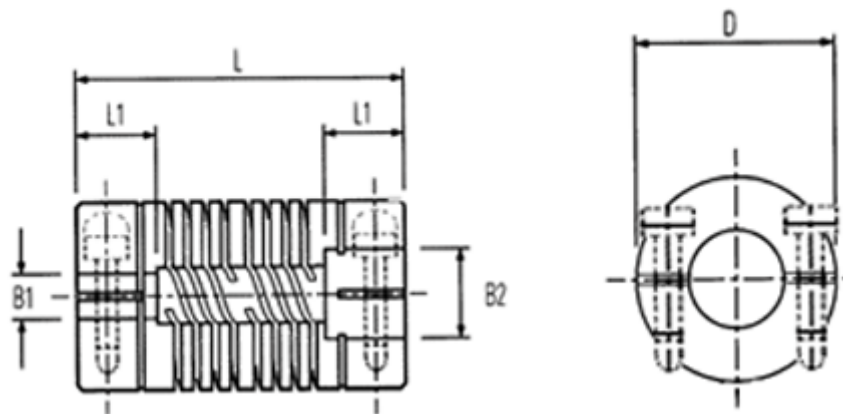

B2: Pre-drilled	= 3.0	Max parallel displacement = 5
B2: Pre-drilled	= 5.00	Peak Torque NM = 3.00
Cap screw	= M2	
D	= 12.7	
L	= 25.4	
L1	= 6.5	
Max angular displacement	= 0.17	
Max B1 & B2	= 6.35	